

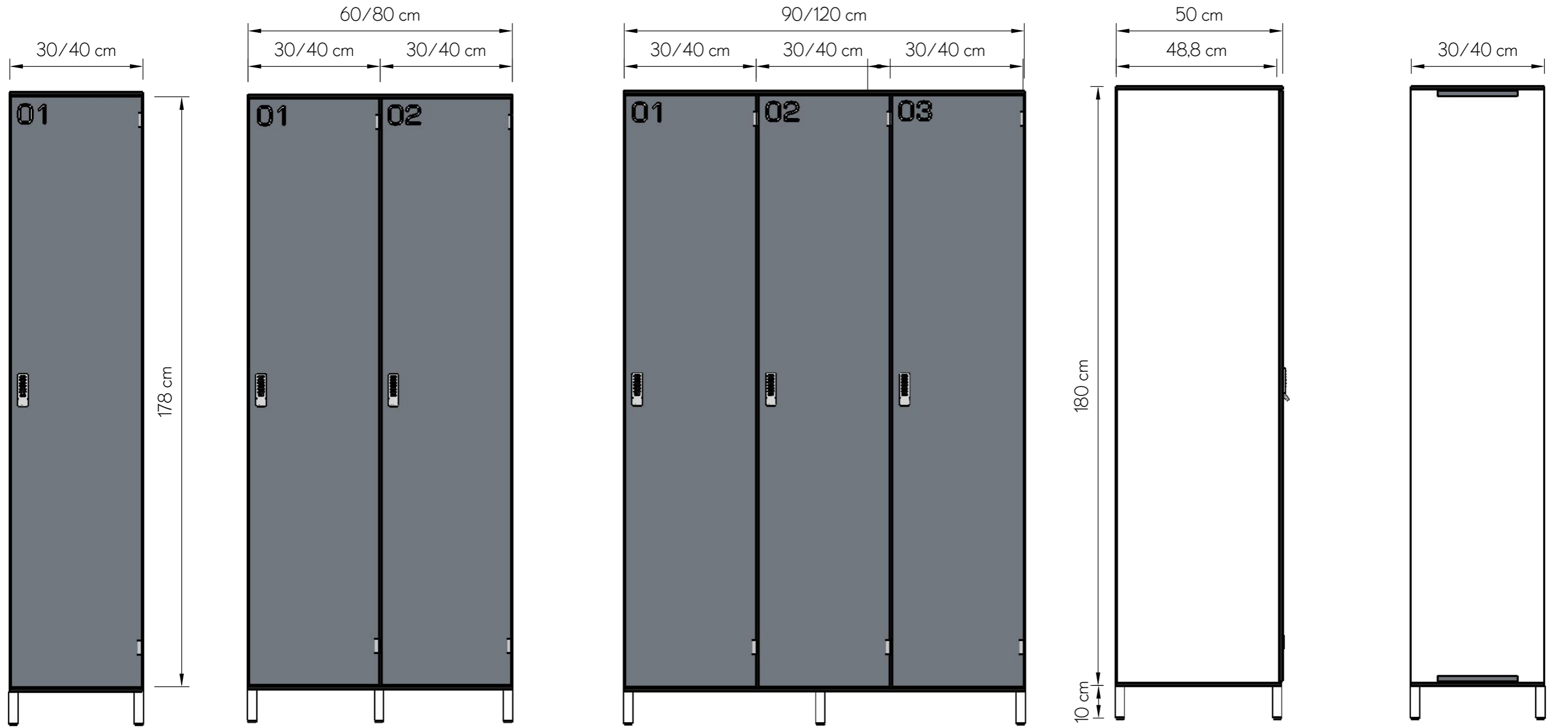

HEBE<sup>MT</sup> full HPL





A1

A2

A3

WIDOK Z BOKU

WIDOK Z TYŁU  
WENTYLACJA

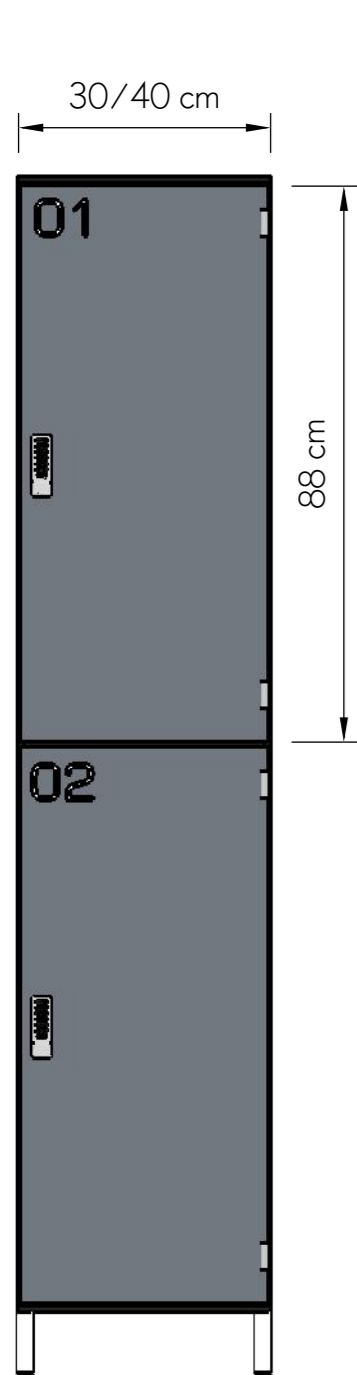

B2

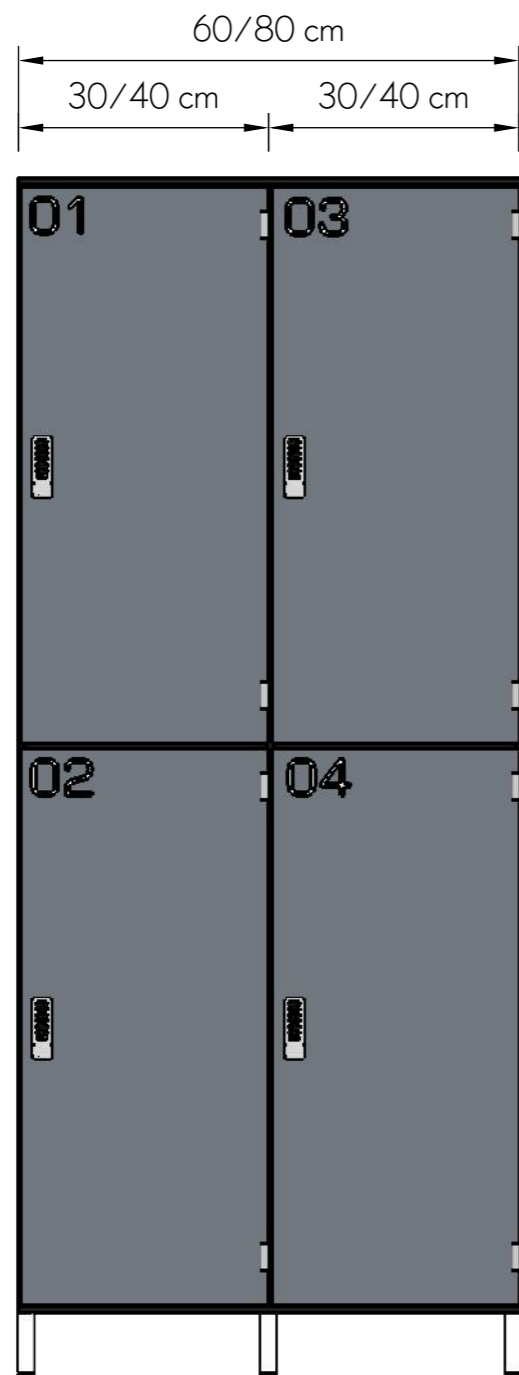

B4

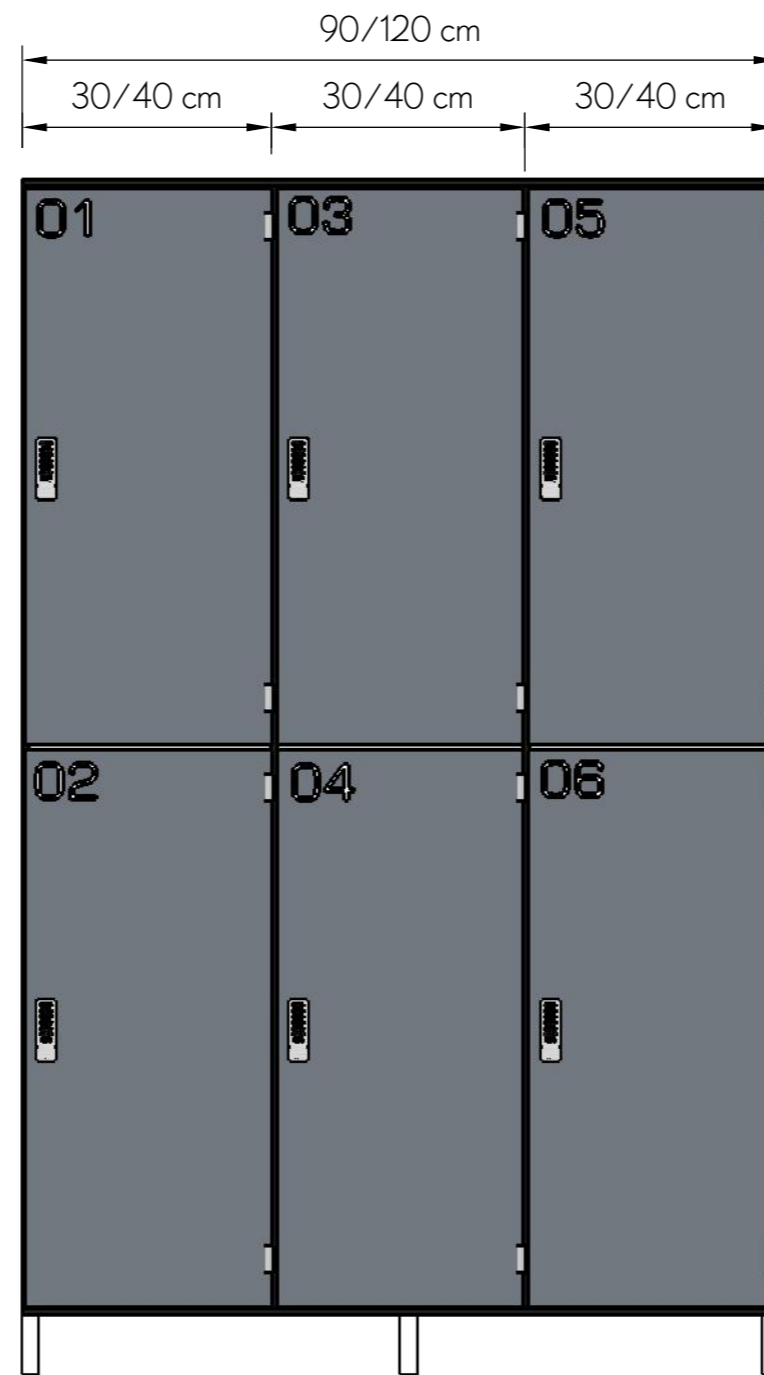

B6

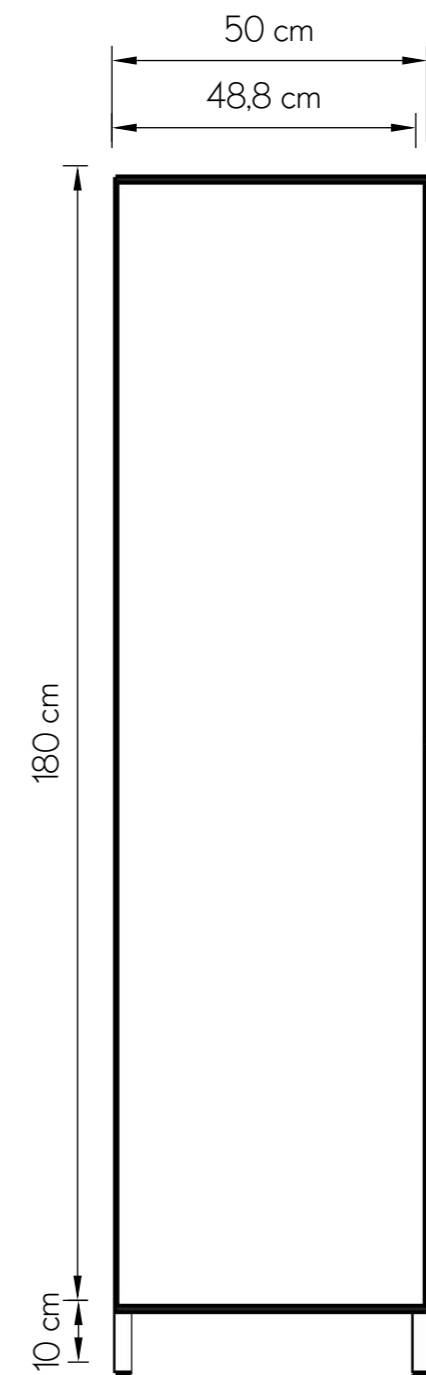

WIDOK Z BOKU

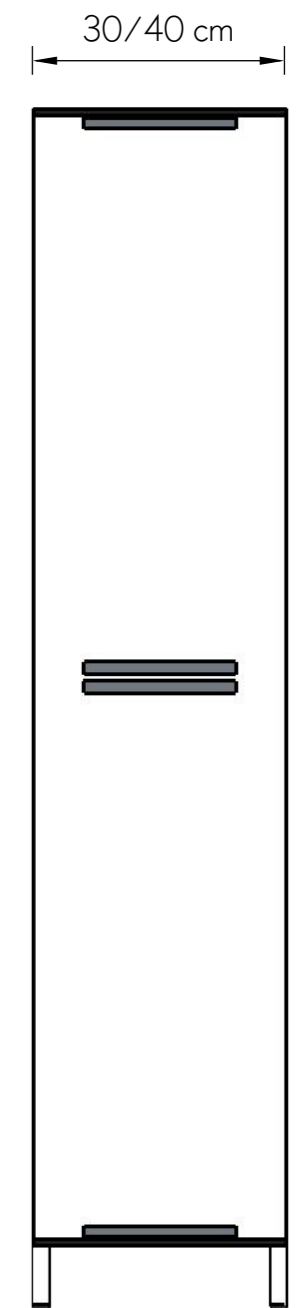

WIDOK Z TYŁU  
WENTYLACJA

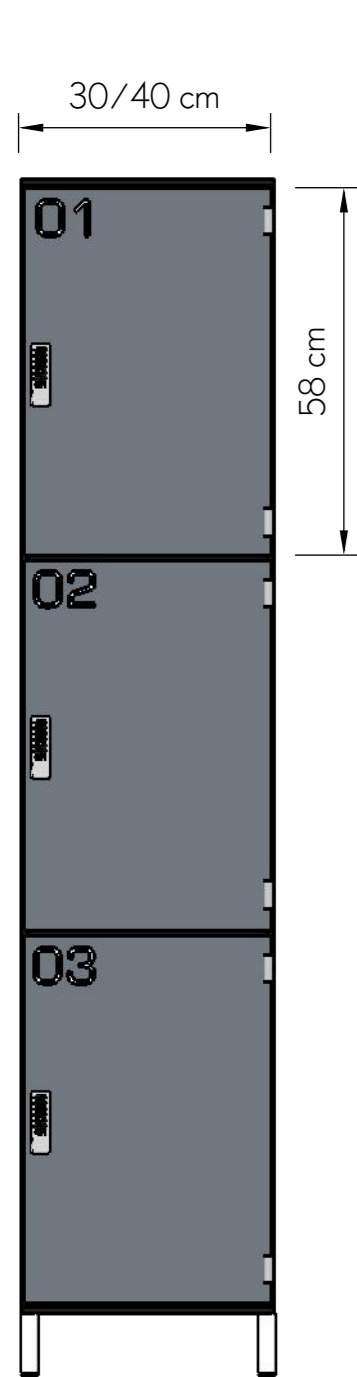

C3

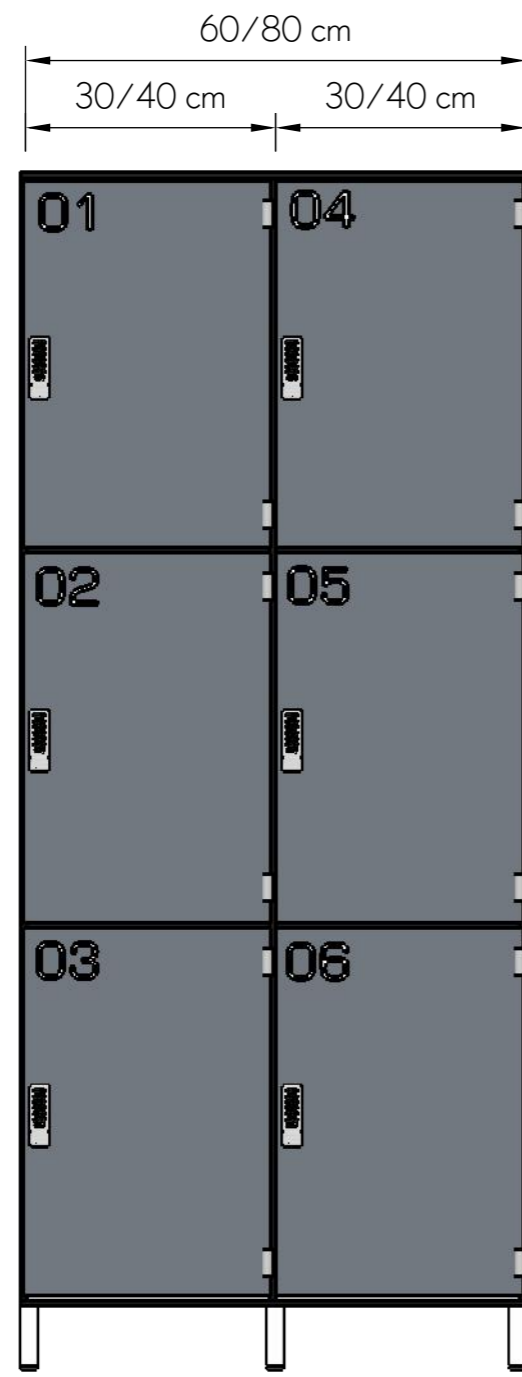

C6

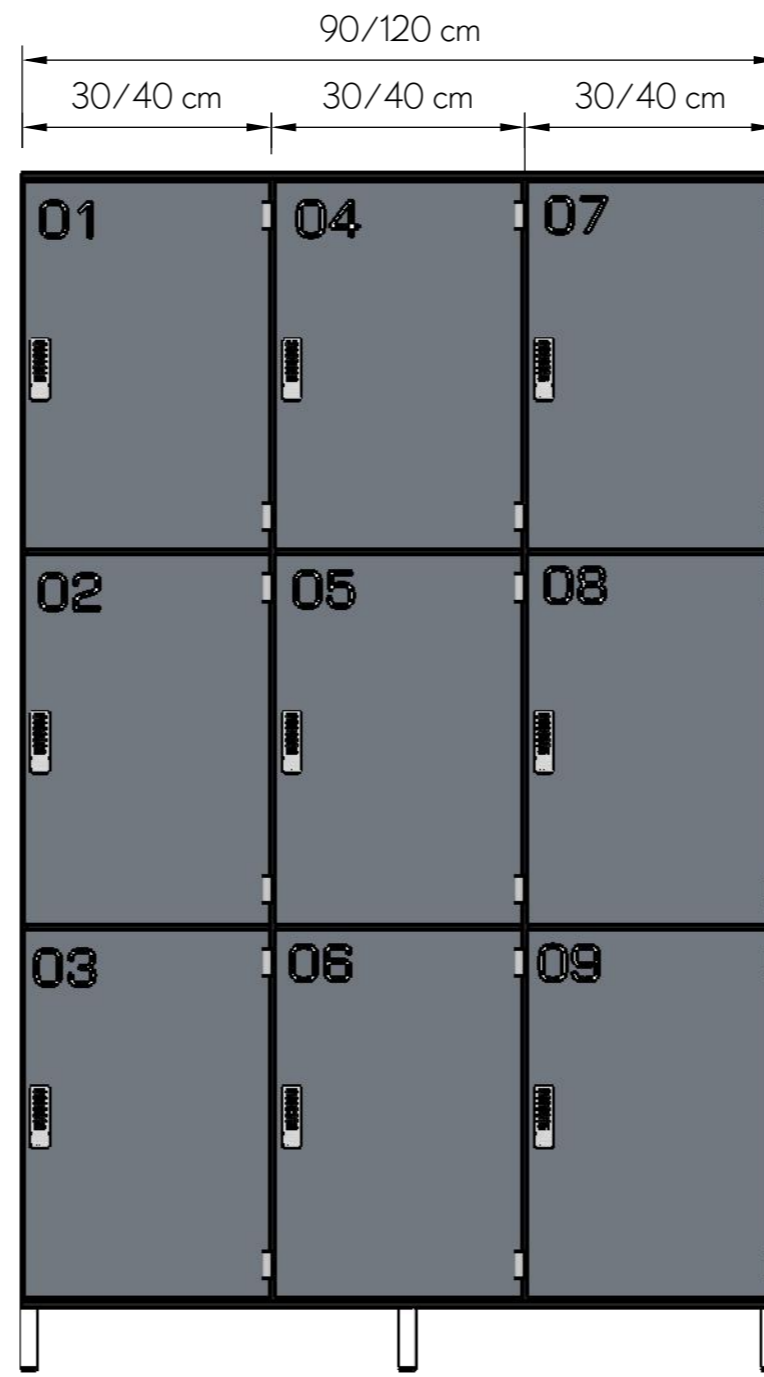

C9

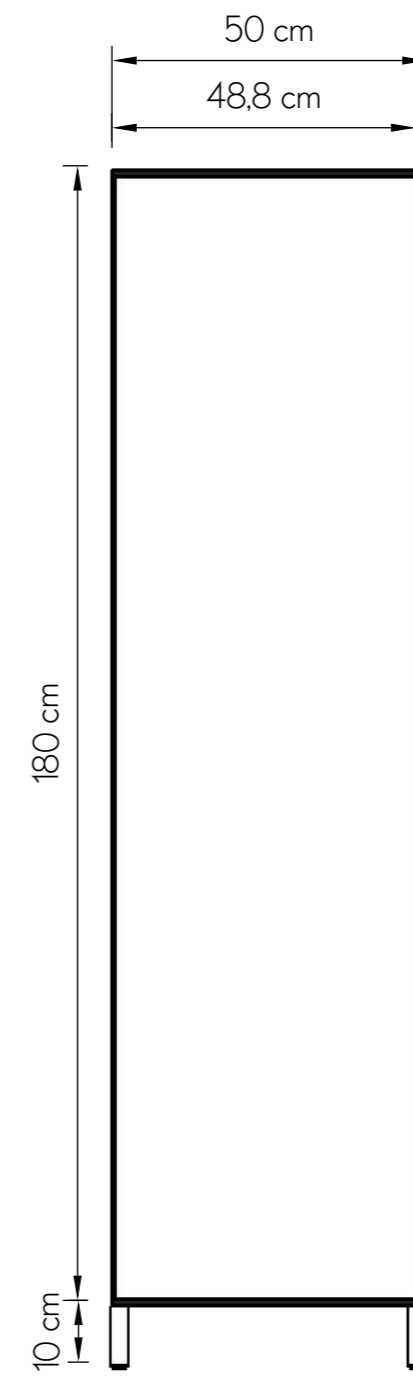

WIDOK Z BOKU

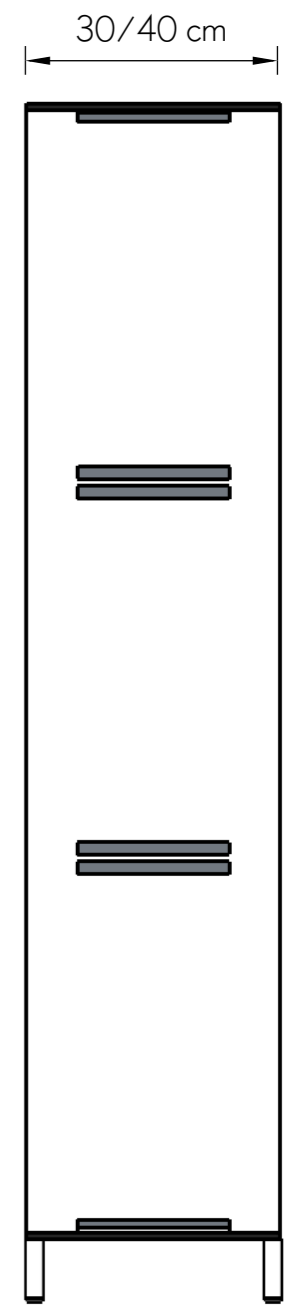

WIDOK Z TYŁU  
WENTYLACJA

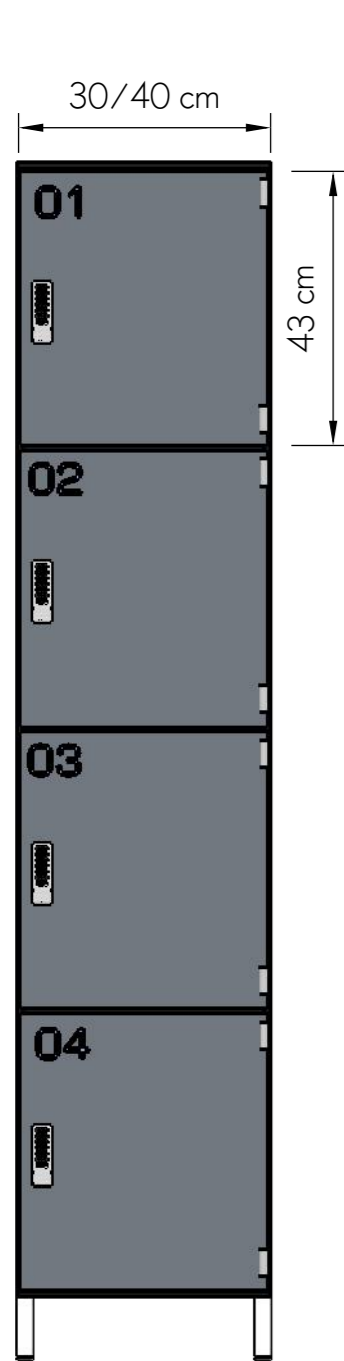

D4

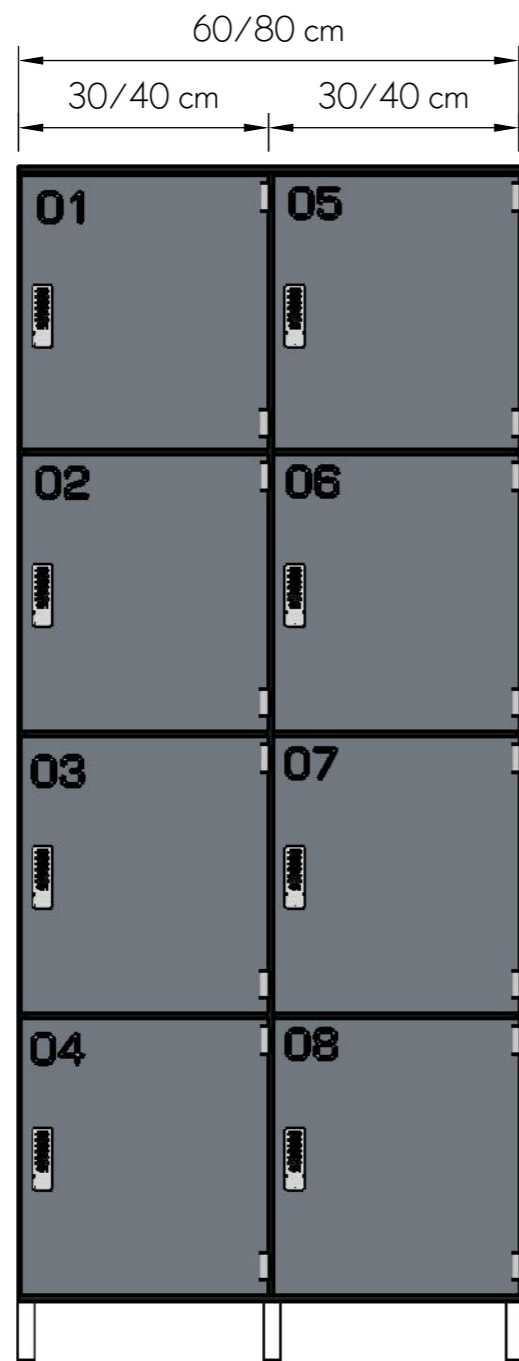

D8

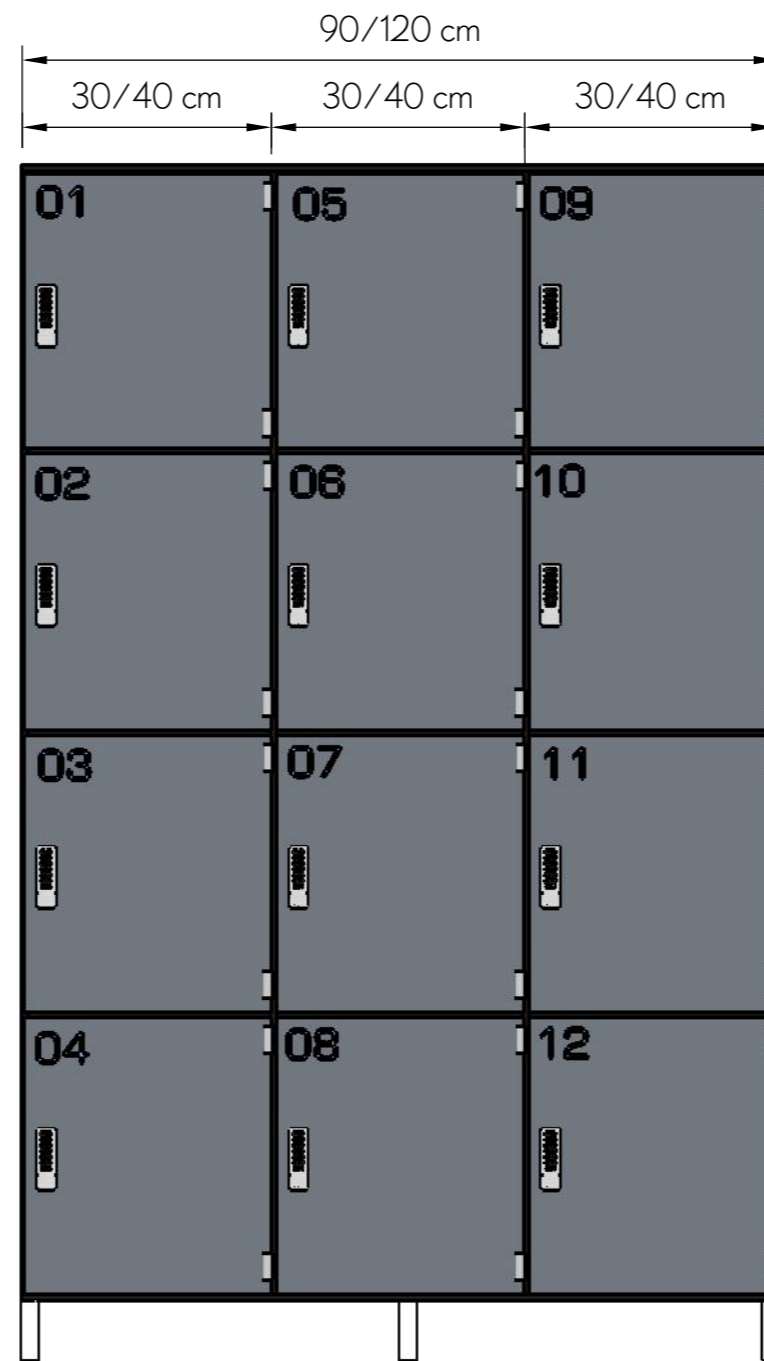

D12

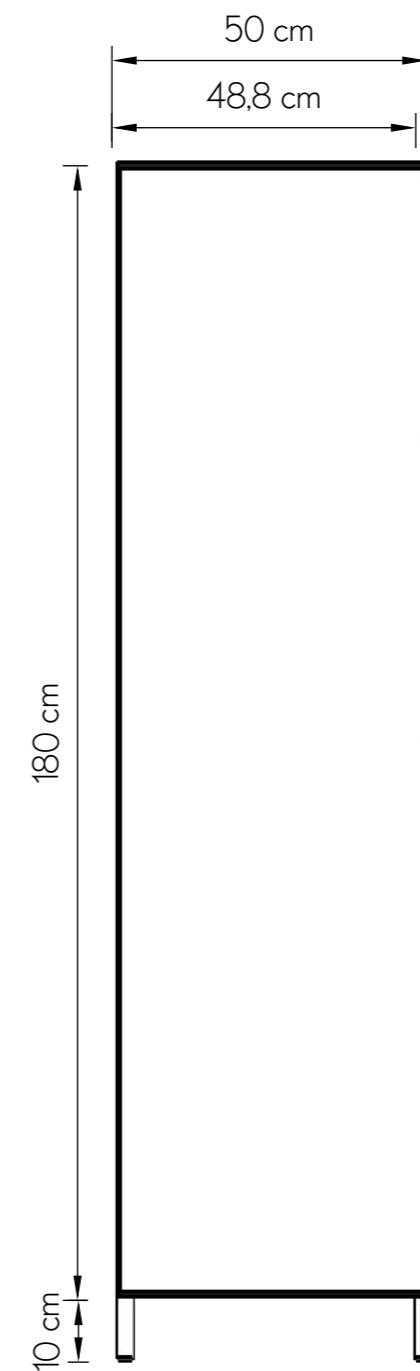

WIDOK Z BOKU

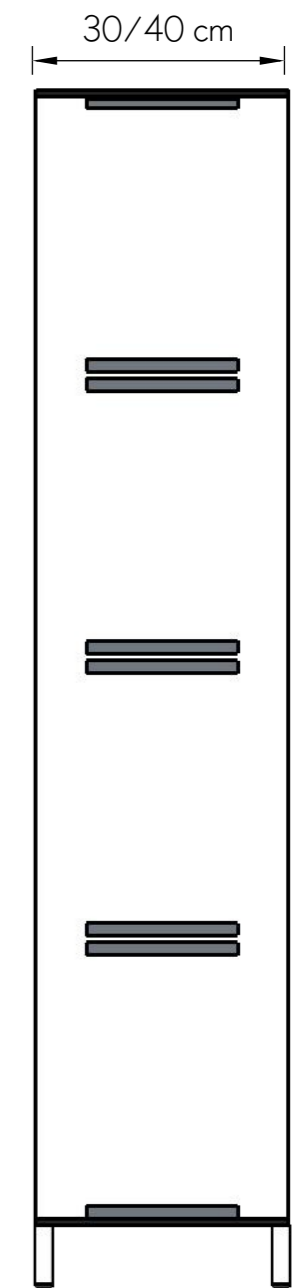

WIDOK Z TYŁU  
WENTYLACJA

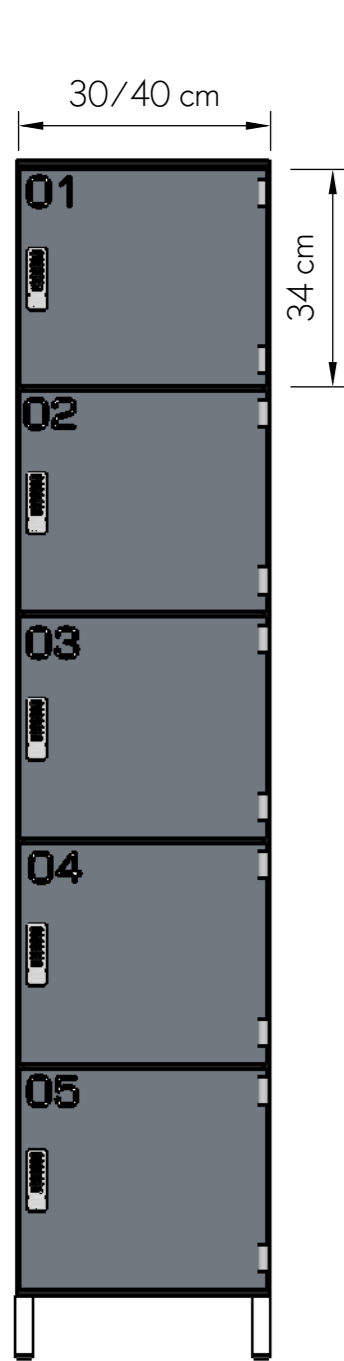

E5

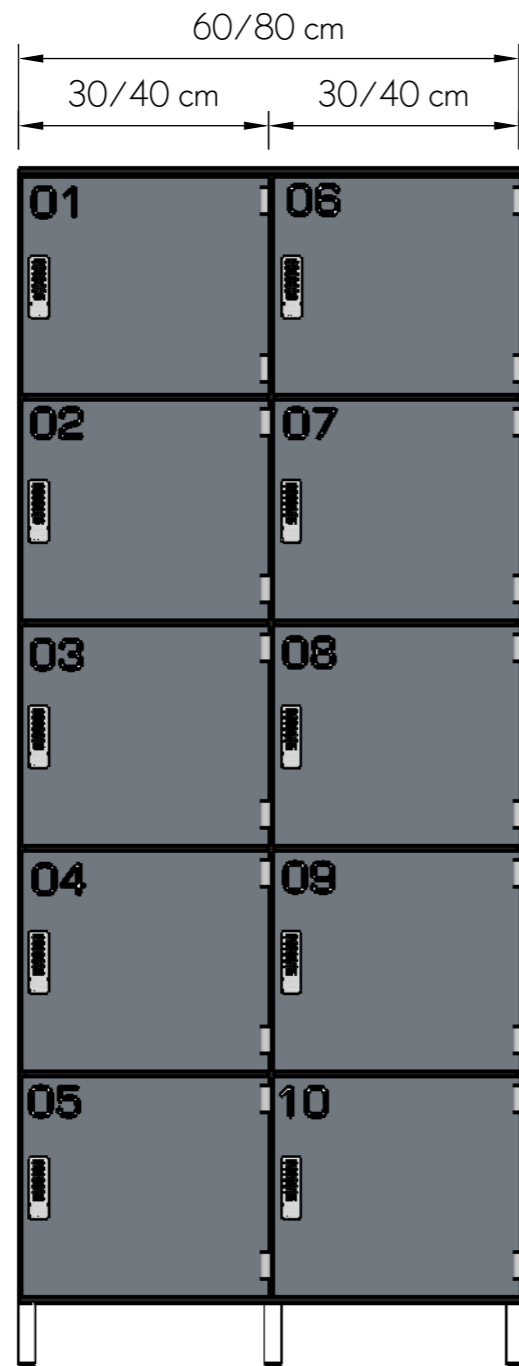

E10

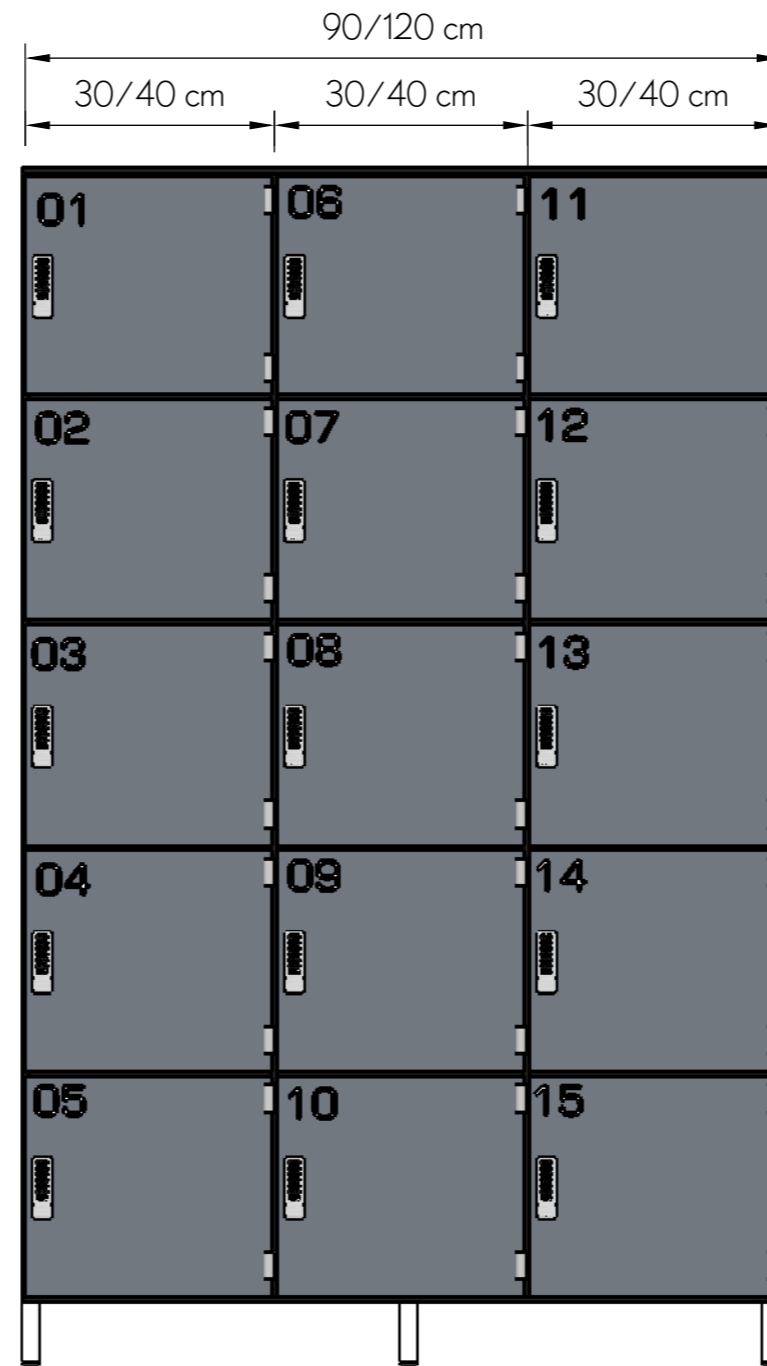

E15

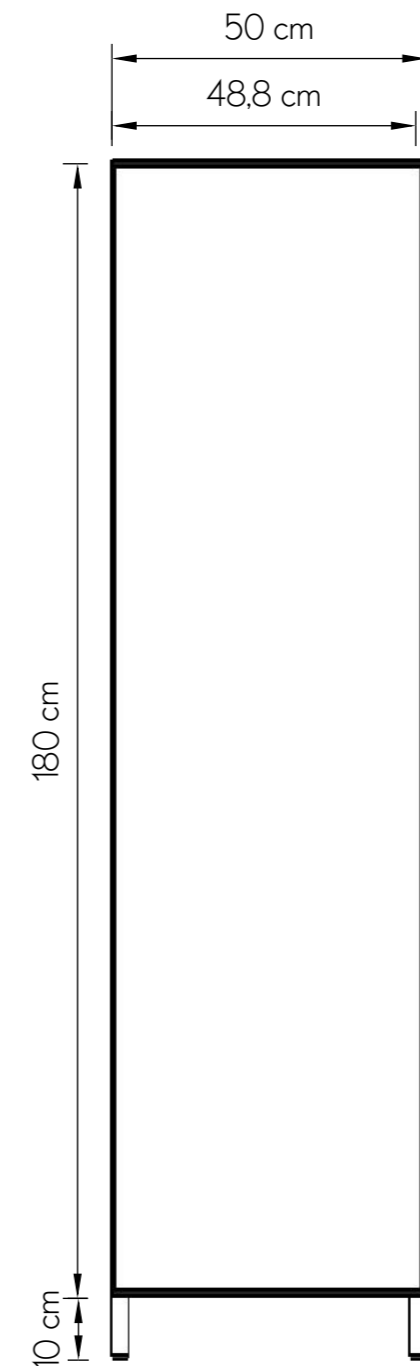

WIDOK Z BOKU

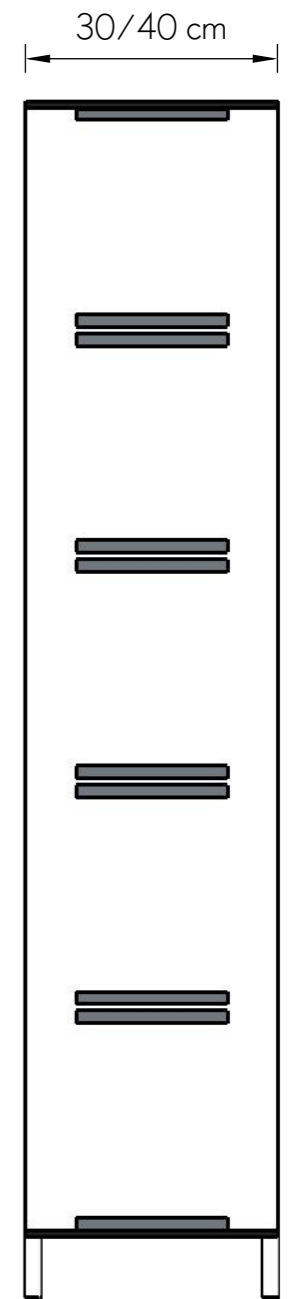

WIDOK Z TYŁU  
WENTYLACJA

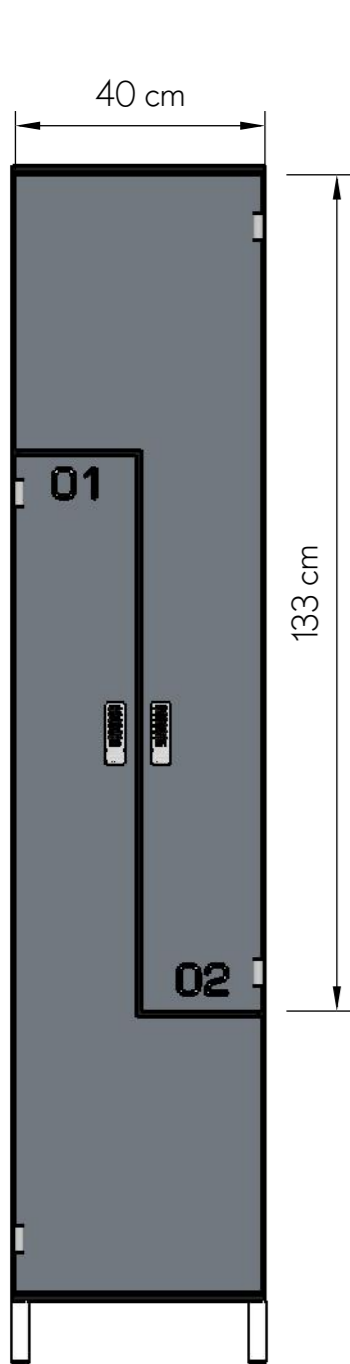

L2

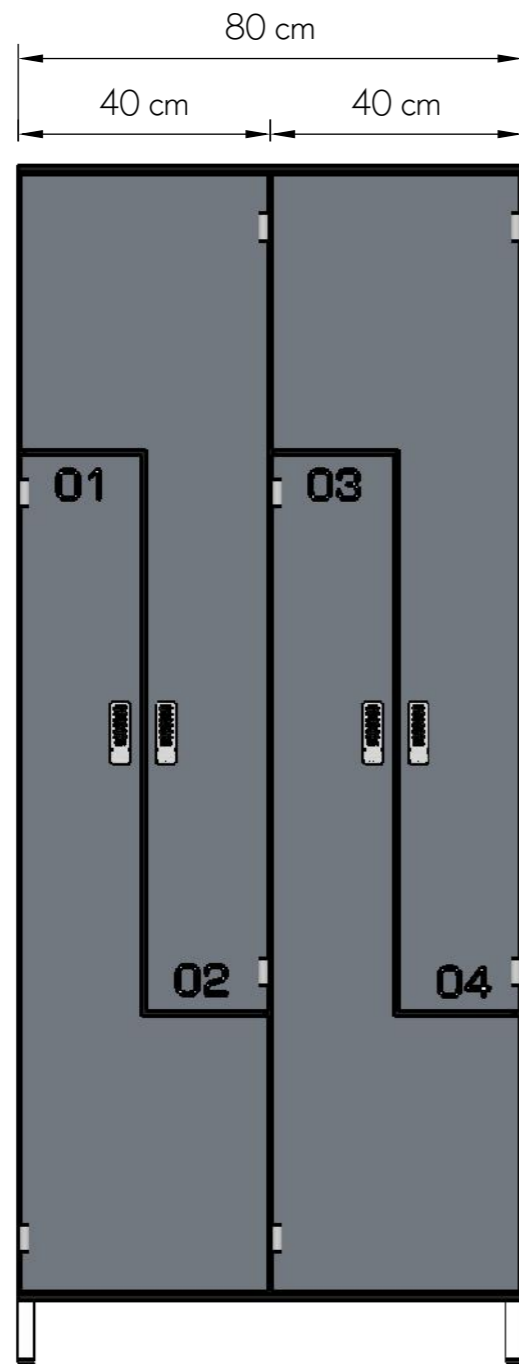

L4

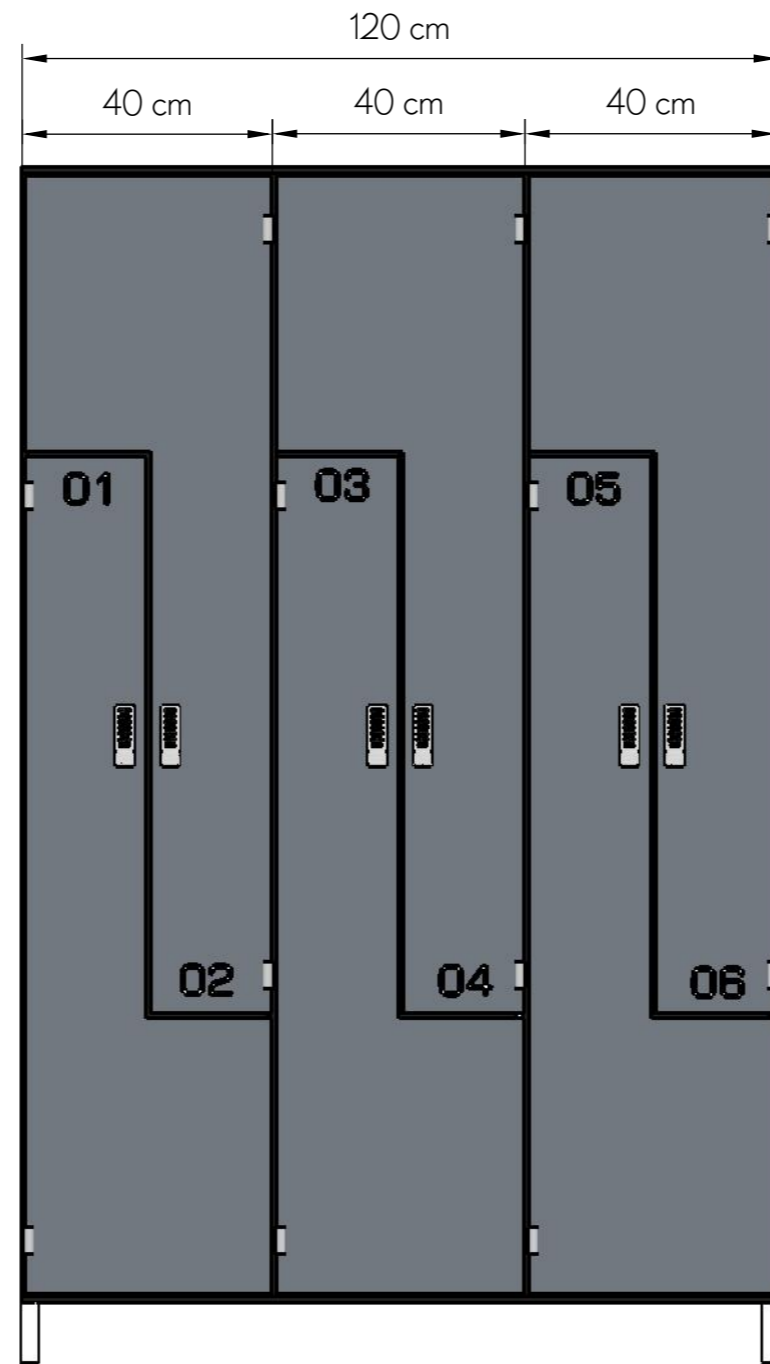

L6

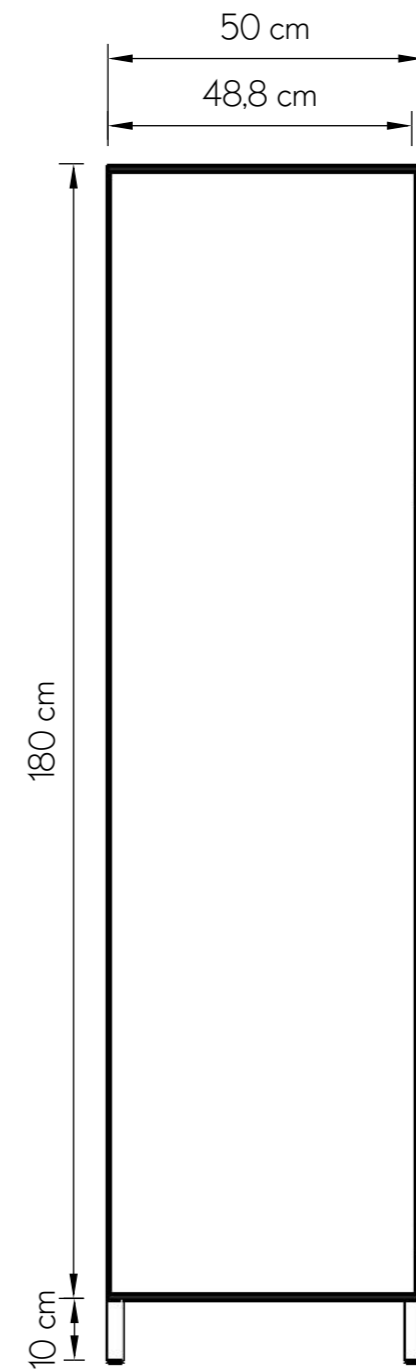

WIDOK Z BOKU

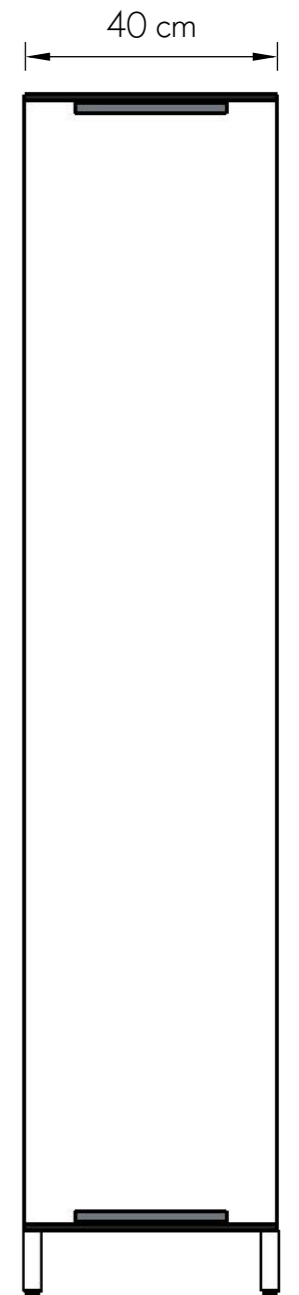

WIDOK Z TYŁU  
WENTYLACJA



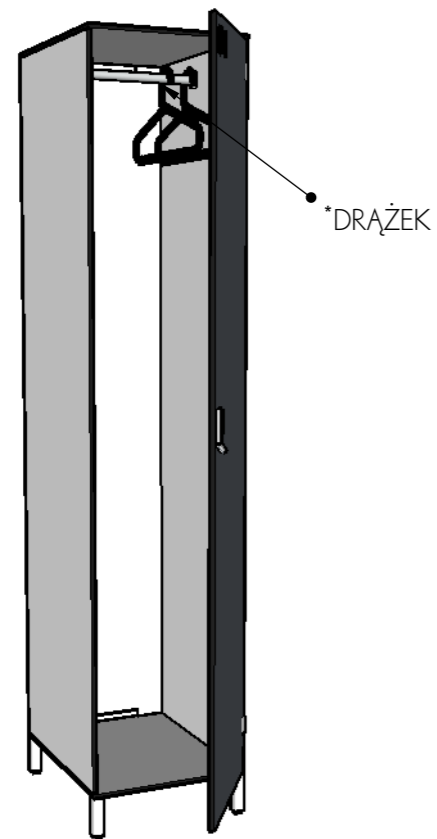

MODEL A

\*MOŻLIWOŚĆ ZAMONTOWANIA DODATKOWEJ PÓŁKI  
\*DRAŻEK Z 3 HACZYKAMI

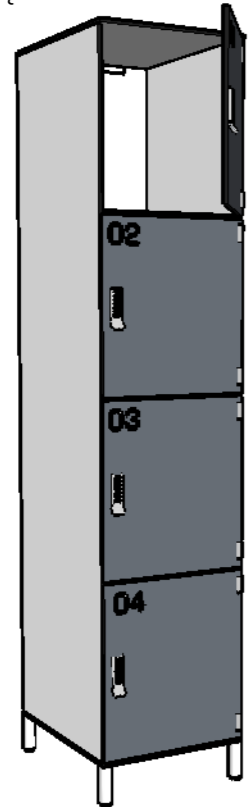

MODEL D

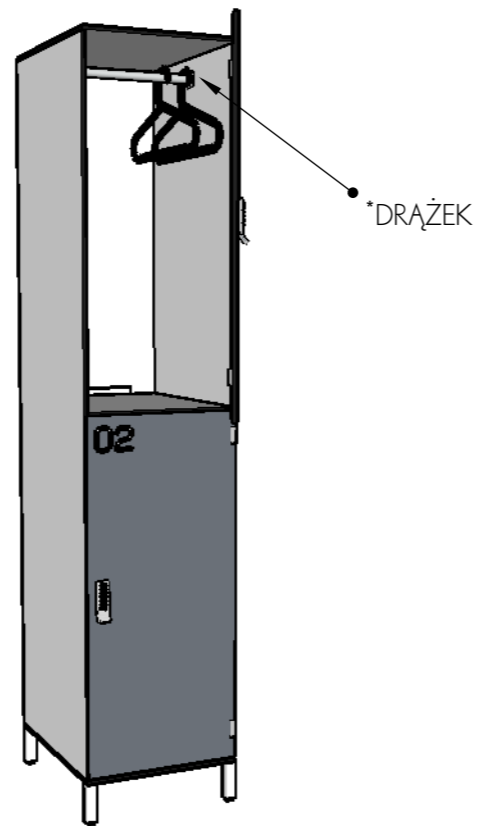

MODEL B

\*DRAŻEK Z 3 HACZYKAMI

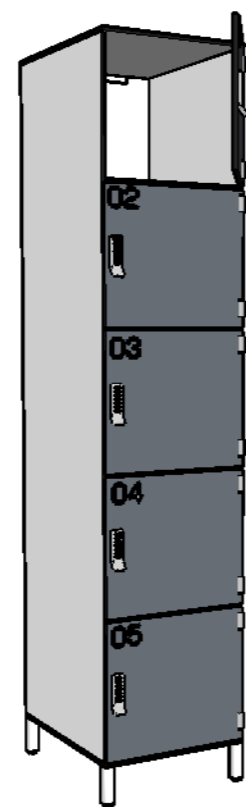

MODEL E

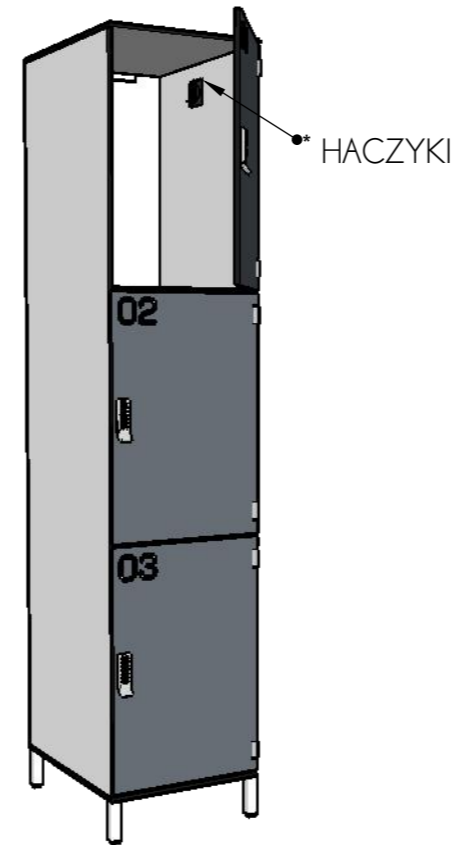

MODEL C

\*DODATKOWE HACZYKI

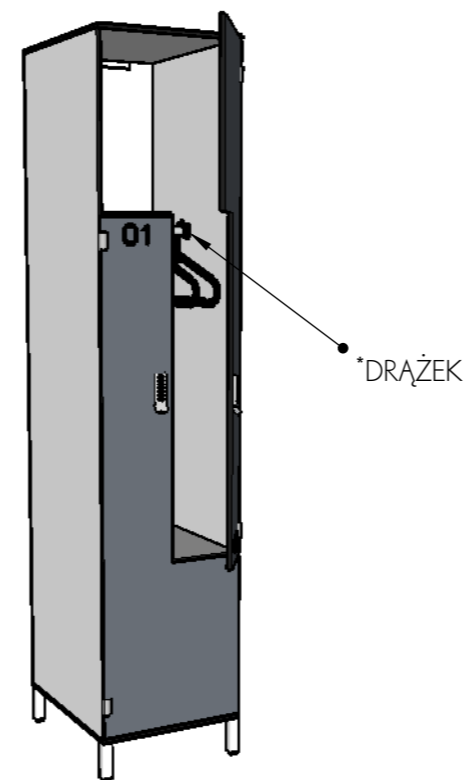

MODEL L

\*MOŻLIWOŚĆ ZAMONTOWANIA DODATKOWEJ PÓŁKI  
\*DRAŻEK Z 3 HACZYKAMI

KORPUS  
PŁYTA KOMPAKTOWA HPL 10 MM



KOLORY STANDARDOWE  
ZBLIŻONE DO PALETY RAL



KOLORY I STRUKTURY NIESTANDARDOWE

FRONT  
PŁYTA KOMPAKTOWA HPL 10/12 MM

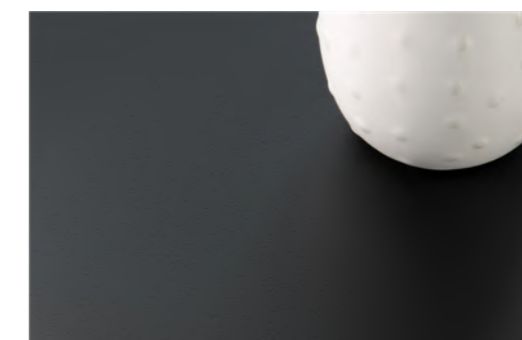

MONOKOLORY



DEKORY DREWNOPODOBNE

WYMIARY STANDARDOWE

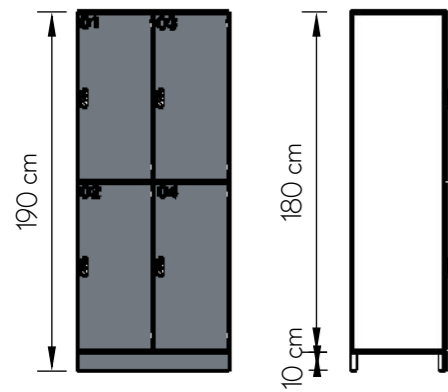

SZAFKA Z COKOLEM

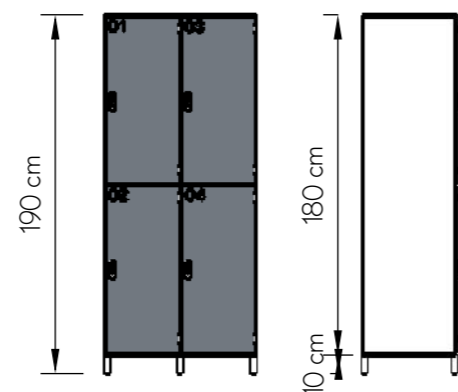

SZAFKA NA REGULOWANYCH  
NÓŻKACH

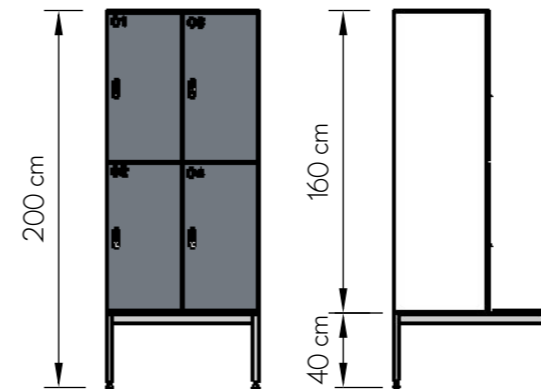

SZAFKA NA ŁAWCE Z PŁYTY HPL

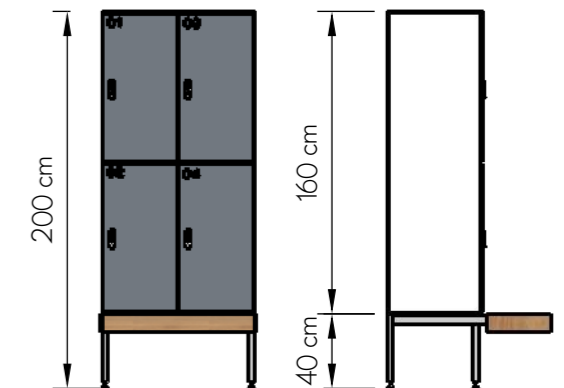

SZAFKA NA ŁAWCE LPP  
Z PŁYTY PŁYTY HPL

WYMIARY NIESTANDARDOWE

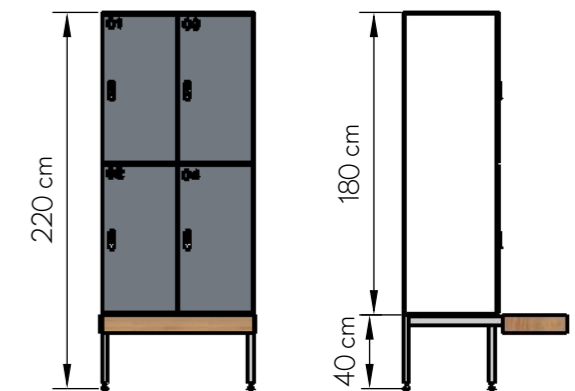
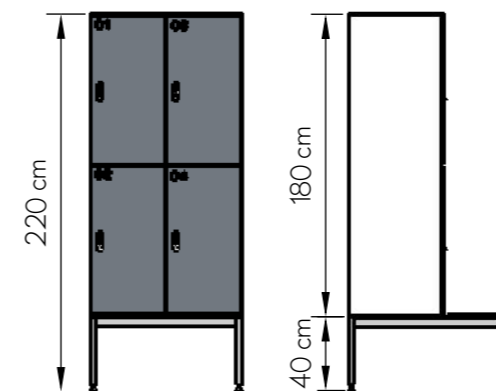
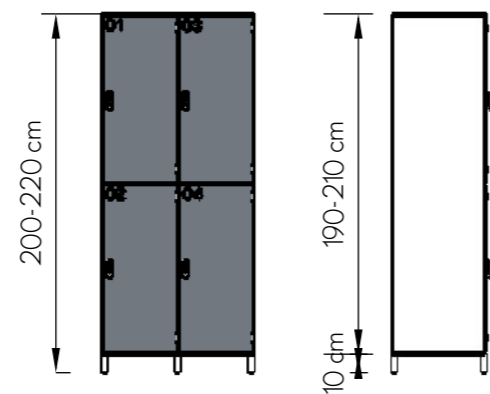
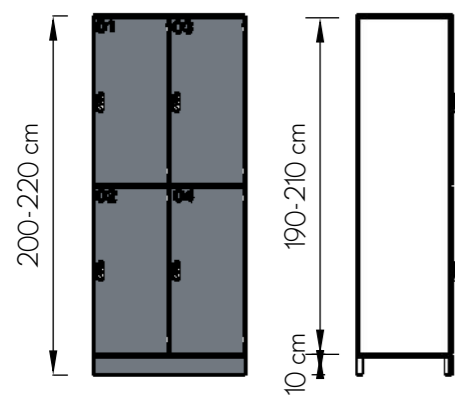

KORPUS, FRONT ORAZ SIEDZISKO Z PŁYTY KOMPAKTOWEJ HPL

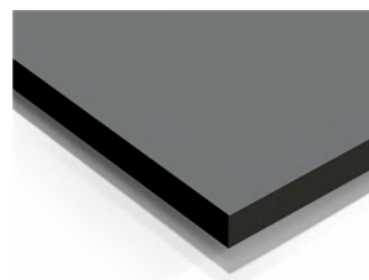

TO WARTWOWA PŁYTA WYSOKOCIŚNIENIOWA HPL  
PRODUKOWANA ZGODNIE Z NORMĄ EN 438-4  
TYPU CGS DO WYMAGAJĄCYCH ZASTOSOWAŃ.  
POWIERZCHNIA NIE POSIADA PORÓW, JEST ŁATWA  
W DEZYNFEKCJI, ODPORNA NA AGRESYWNE,  
KWAŚNE ŚRODKI CZYSZCZĄCE.

